

HEXTIO

AIR PURIFIER

USER GUIDE AND INSTRUCTIONS



RADIC 8

Dear Customer

Thank you for purchasing a HEXTIO Air Purifier, this is clean air technology at its best. This product is packed with power and technology to provide fast and efficient clean air. We hope that you enjoy using your new unit!

The Viruskiller technology was tested against the following major airborne viruses: Poliovirus, Influenza Virus, Adenovirus and Coronavirus DF2 by the Institute of Medical Sciences, School of Medicine National Kangwon University. Testing proves a near 100% reduction for these viruses. The results for these airborne pathogens are the same for all of the Viruskiller range.

Radic8's Viruskiller range (Hextio, VK 401, VK 102 and VK 103) is not FDA-cleared / FDA-approved.

READ ALL INSTRUCTIONS BEFORE USING YOUR AIR PURIFIER

When using your HEXTIO, basic safety precautions should be observed, including the following:



WARNING

TO REDUCE THE RISK OF FIRE, ELECTRIC SHOCK, OR INJURY

- Use the unit only for its intended use.
- To protect against a risk of electric shock, do not immerse any part of the system in water or in any other liquids.
- This appliance is NOT a toy.
- This appliance is NOT to be used by children or persons with reduced physical, sensory or mental capabilities.
- Children should be supervised at all times.
- Never look directly at a burning ultra-violet light, as this may permanently damage your eyes.
- To reduce the risk of an electric shock or damage to the unit, switch the off and unplug before cleaning or performing any maintenance to the unit.
- Heed all warnings
- There are no UV risks associated with the devices in use. The UV reactor chambers and fans are sealed to ensure there is no risk of harm and UV exposure. Indoor air quality sensors on the devices also highlight when the filters on units need to be cleaned and replaced.

SUMMARY

IMPORTANT SAFETY INSTRUCTIONS	2
SYMBOLS USED IN THIS MANUAL	2
INSTALLATION SAFETY	4
KEY PARTS AND COMPONENTS	6
THE UNIT	6
LED LIGHT FUNCTIONS.....	7
REMOTE CONTROL	7
DIRECTIONAL AIRFLOW HOOD INSTRUCTIONS	8
CLEANING AND MAINTENANCE	8
REPLACING THE FILTERS	8
REPLACING THE REACTOR CELL	9
TROUBLESHOOTING	10
CUSTOMER SERVICES.....	11
SPECIFICATIONS	11



Warning - Indicates important safety instructions that must be followed to avoid injury.



Caution - Indicates important information to your attention to avoid the risk of injury or damage to the unit



Prohibited - Indicates forbidden action



INSTALLATION SAFETY

Should the unit emit smoke, unusual odors or make any strange noises, immediately switch off the unit unplug it. Contact your distributor.



No form of water or liquid should enter the unit. Should this occur, immediately switch off the unit and unplug it. Contact your distributor.

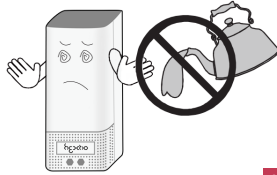

Do not place any heavy objects on the power cord as this may cause a fire and/or an electric shock.



Make sure the power cord is plugged firmly into the outlet. If the power is not plugged in correctly, this may cause a fire.

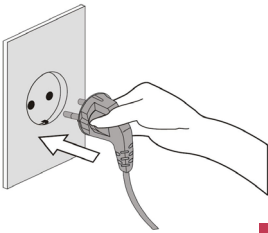

Do not touch the plug with wet hands, as this may cause serious injuries.



Do not block the air inlet of the unit, as this will reduce the airflow and result in poor performance and damage the unit.



Do not spray inflammable materials near the unit, as this is a fire hazard.

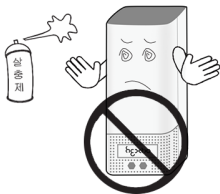

Do not sit, stand or place heavy objects on the unit, as this may result in injury and/or damage to the unit.

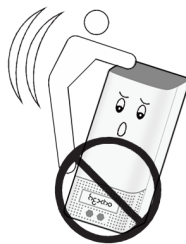

Do not move the product while it is switched on, as this may cause a fire and/or an electric shock.



Do not alter or modify the plug or cord of this unit as it could cause a fire or an electric shock.



10

Use the proper power cable and outlet, do not over-load the outlets with several cords simultaneously.

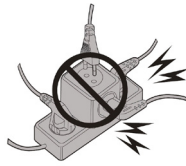

11

Keep the product away from inflammable gases, liquids, or other combustible substances, as this could cause an explosion.

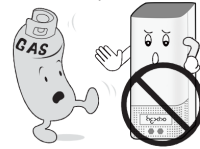

12

To protect against a risk of electric shock, do not immerse any part of the system in water or in any other liquids.

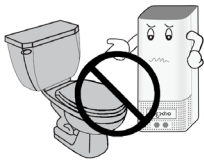

13

Do not attempt to repair or replace any part of this equipment unless it is specifically recommended in this manual. All other services should be referred to a qualified technician.



14

Switch the unit OFF, when cleaning a room.

After cleaning, it is important to ventilate the room properly before switching the unit back ON.



15

Switch the unit OFF, while cooking.

Oils released while cooking may reduce the life span of the unit. After cooking, the room must be ventilated to remove oils. You may now switch the unit ON to remove any smells.



16

Airflow must NOT be restricted or obstructed, by large items such as furniture, electronic items or curtains.

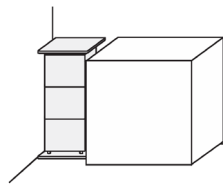

17

Daily room ventilation for at least 30 minutes.

The unit is designed to purify your indoor air and will do this effectively when used correctly. Good indoor air quality also requires room ventilation. We recommend opening windows and doors, or operating the air conditioning, for a least 30 minutes a day.

18

Position the unit at least 3 meters away from the bed to avoid excessive cooling caused from sleeping in direct airflow.



19

Use a dedicated power outlet.

Lightning or static electricity could affect the circuit and may cause a fire or damage the unit. To avoid this, plug the unit into a dedicated, grounded outlet.

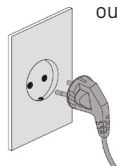

20

KEY PARTS AND COMPONENTS

THE UNIT

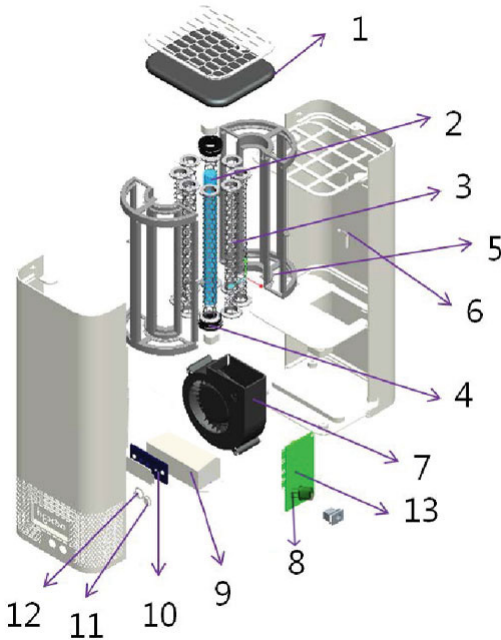

1	Carbon Filter + HEPA Filter
2	UVC Lamp
3	Hexagon TiO ₂ Filter
4	Rubber Holder
5	Reactor Tray
6	Mirrored Chamber
7	BLDC Sirocco Fan
8	VOC Sensor
9	UVC Ballast
10	Logo LED
11	Remote Control Sensor
12	Power Switch
13	Control Board

LED LIGHT FUNCTIONS

The mode is indicated by the color of the Logo LED as follows:

Blue – automatic mode. Indicates good air quality and normal fan speed of 20%

Red – automatic mode. Indicates poor air quality and high fan speed of 100%

Green – manual mode. Fan power can be set to 3 speeds; low 20%, medium 50%, or high 100%

Red, flashing continuously – indicates reactor cell replacement is due.

REMOTE CONTROL

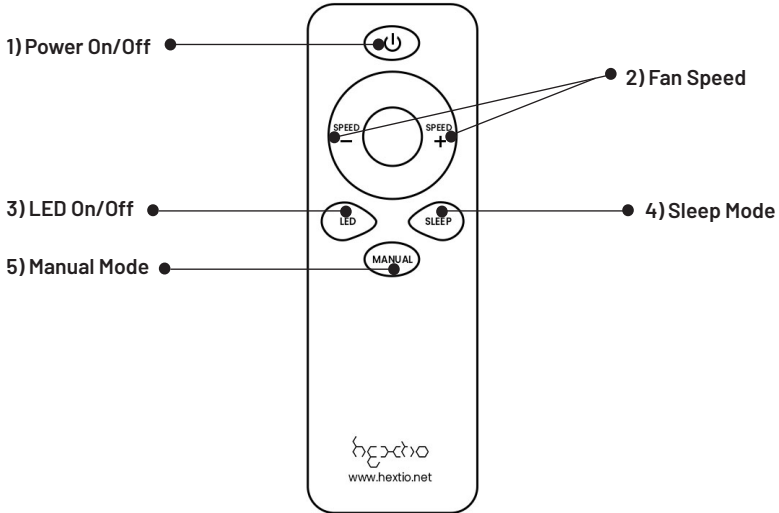

No	Name	Function
1)	Power ON/OFF	To switch the unit ON/Off. You will hear a beep sound.
2)	Fan Speed	To increase the Fan Speed, first press the MANUAL button, then SPEED + to increase the speed and Speed - to decrease the speed. Fan speeds: FAN 1(20%), FAN 2(50%), FAN 3(100%)
3)	LED On/Off	Turns the LED lights ON/OFF.
4)	Sleep	When sleep button is pressed, the fan switches to very low (10%) and all LED lights are switched off.
5)	Manual Mode	This button switches the unit from Automatic mode, to Manual Mode, where you can adjust the fan speed.

DIRECTIONAL AIRFLOW HOOD INSTRUCTIONS



To remove, pull firmly from one side of the hood, do not pull from the front.

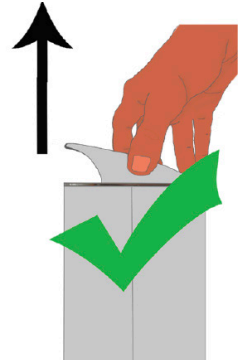

CLEANING AND MAINTENANCE

REPLACING THE FILTERS

1. Remove the filter cover after unscrewing the 2 screws on the sides.

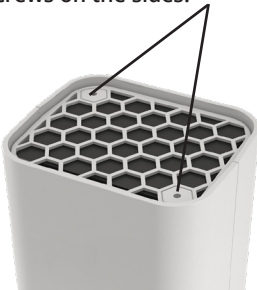

2. Place the new filter (black side up).



3. Place the filter cover back and tighten the 2 screws to secure it.

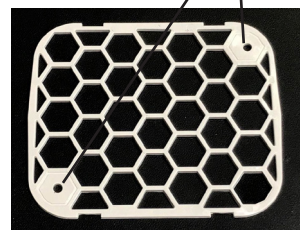

REPLACING THE REACTOR CELL

The reactor cell must be replaced after 8000 hours of working. The unit has an Integrated timer and will let you know when the 8000 hours have passed, by displaying an Intermittent red light. **Switch the unit OFF before doing any maintenance work.**

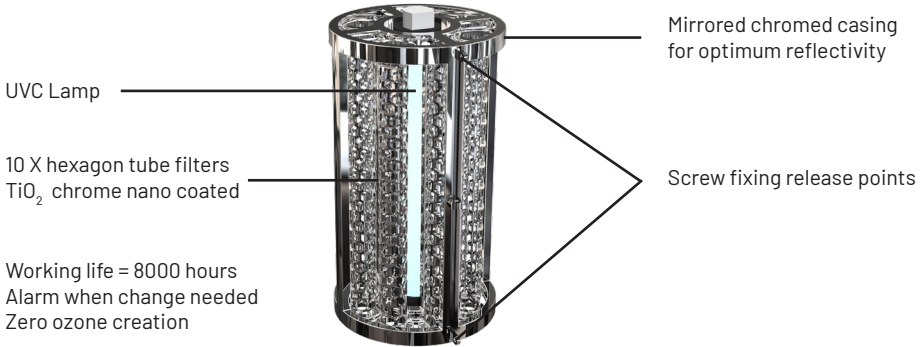

1	Unscrew the 2 corner screws securing the filter cover and remove the filter cover and the filter.	
2	Remove the 2 screws shown in this image:	
3	Flip the unit upside down, detach the 4 rubber feet and loosen the 4 screws underneath them.	
4	Open the body and loosen the 4 screws that secure the reactor cell to the unit. (opening the unit might be a bit difficult at first, but don't worry, it will open up if you've followed the above steps).	

5	Detach the wire connecting the old reactor cell to the unit.
6	Replace with the new reactor cell and assemble in reverse order. The used reactor cell is fully recyclable. As a consumer, it is your responsibility to dispose of it properly.
7	Now switch your HEXTIO back on, press and hold the power button for 10 seconds, to reset the warning timer. Your HEXTIO is ready for the next 8000 hours.

TROUBLESHOOTING

Before you call for service, review this list. It may save you time and expense. This list includes common occurrences that are not the result of defect in workmanship or materials.

Problem	Possible cause	Solution
The product will not turn on	The plug is not properly inserted in the grounded outlet.	Plug the device into a working grounded outlet.
	The remote control is out of battery power	Replace the batteries according to the polarity.
Weak airflow and noise from the product.	The pre filter has accumulated too much dust.	Clean the pre filter to avoid this problem Also change the HEPA filter when due.
The timer preset does not work.	The timer function has not been activated.	Set the timer, according to the instructions in this manual.
The air purifying function does not work properly.	The indoor air is heavily contaminated	The room requires ventilation.
	The pre filter is blocked	Clean the pre filter.
	The HEPA filter is blocked	Replace the HEPA filter.
	The room is too large for the unit	Select the right Viruskiller according to the room size.
	The airflow is restricted	Make sure there is enough clearance around the product and that the air inlet and outlet of the unit are unobstructed.
Strange smell is emitted from the device.	New product odour	The coating of the reactor cell might release a small amount of harmless odor. It should disappear in one to two weeks.
	Moist filters	When cleaning the pre filter with water, make sure it is completely dry before reinstalling.
	The product has been used in environments with a high concentration of food odors.	Food odors are oily and can penetrate into the filter or the reactor chamber. Use proper ventilation.
	The product has been used in environments with a high concentration of smoke.	In areas emitting too much smoke, the performance of the reactor cell may be affected. Use proper ventilation.

CUSTOMER SERVICES

In this manual, you will find a card containing details of your limited warranty. Please contact your distributor if you encounter issues with your unit or to procure replacement filters or reactor chamber when these reach their end of life.

Damage or malfunction caused by negligence, abuse, unauthorized repairs or use not in accordance with the User Guide will not be covered. All warranties are rendered void and the cost of repair will be payable by the user in the case of damages caused by:

- putting in foreign objects (such as water, liquids, fragrance oils, toys etc.) in or out of the unit;
- transportation or handling;
- use of products such as benzene or thinners;
- incorrect power supply or output voltage;
- breakdown or loss of part caused by unauthorized disassembling or modifications;
- repair or replacement undertaken by unauthorized persons;
- non-adherence to the instructions provided in this user guide, and as given by the local customer service center;
- careless or improper use;
- caused by operating the product in a corrosive or moist environment.

SPECIFICATIONS

The company reserves the right to make changes to the design and specifications of the product without prior notice.

Description	Air Purifier
Brand	VIRUSKILLER
Model No	HEXTIO
Max. Elec. Consumption	15 watt
Net Weight	1.33 Kg 2.93 Lbs
Net Dimensions	330 x 106 x 126 mm 13 x 4.17 x 4.96 in
Noise (dB)	40-49
Airflow (CFM)	12-20
UVC Lamps	1 x 6W (253.7 nm)
TiO ₂ Hexagon Filters	10



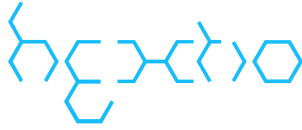

Sales & Design: First Floor, Columbia Mill, Bedford Street, Bolton, BL1 4BA
Tel : +44 (0) 1204 238823,
E-mail: info@radic8.com,

Manufacturer: INBair Korea LTD
3~4F, 72, Jomaru-ro 411 Beon-gil, Bucheon-si, Gyeonggi-do, South Korea
E-mail: inbair01@naver.com, www.inbair.com

Made in Korea | Designed in England

RADIC8